

Type: DA75-NUxx/DxxxE
date / time
quartz clock (DCF77)

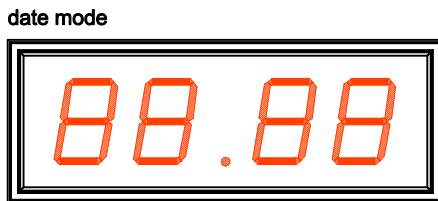
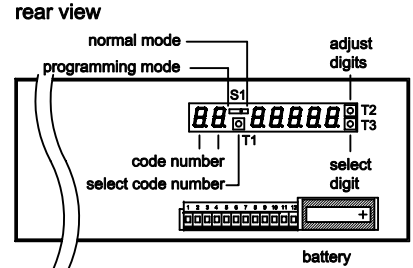
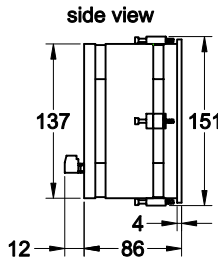
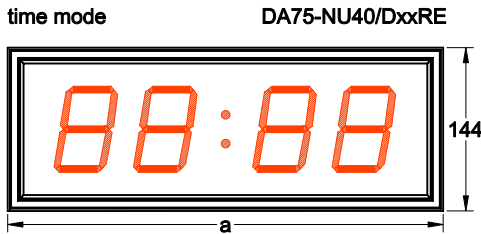

case dimensions

| DA75 | aluminium case powder seam | | bezel width [a] | cutout panel w x h |
|-------------------|--------------------------------------|-----------|-----------------|--------------------|
| | case depth (with terms) : 86 (98) mm | | | |
| DA75-NU __ /DxxxE | | | | |
| time mode | | date mode | | |
| 40 | 88:88 | 40 | 88.88 | 384 |
| 60 | 88:88:88 | 60 | 88.88.88 | 528 |
| | | | | 378 x 138 |
| | | | | 522 x 138 |

programming

| code number | display | description |
|-------------|-----------|--------------------------------------|
| 0 | 0 0 0 0 | adjust time |
| 1 | 0 0 0 0 | adjust date |
| 2 | 0 0 0 0 | adjust year |
| 3 | - - P - - | take-over time with T3 |
| 4 | 0 0 | alternating date / time is displayed |
| | 0 1 | only time is displayed |
| | 0 2 | only date is displayed |
| 5 | max. 99 | time length for time is displayed |
| 6 | max. 99 | time length for date is displayed |
| 7 | 0 - 9 | brightness adjustment |
| | | 0 = bright 9 = dark |

rear connector with screw-type terminals

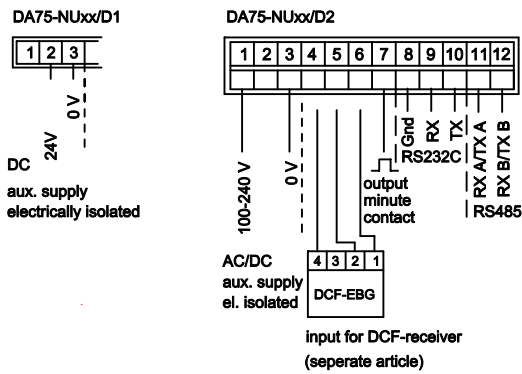

technical data :

| | | |
|---------------------|-----------------|-------------------|
| aux. supply : | DA75-NUxx/D1... | 18 - 35 V DC |
| | DA75-NUxx/D2... | 100 - 240 V AC/DC |
| power consumption : | max. 15 VA | |
| temperature range : | -20 °C...+65 °C | |
| display height : | 76 mm | |
| display colour : | red or green | |
| protection type : | IP65 front | |

wire reference for 2 clocks and 1 DCF-EBG

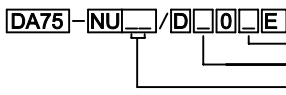
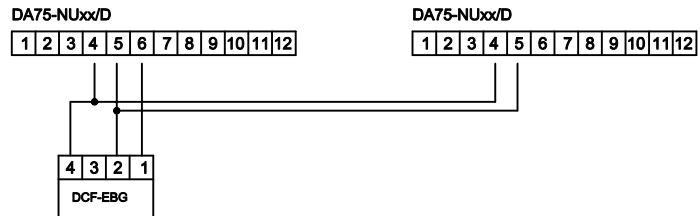

| | | |
|------------------|---------------|---------------|
| display colour : | R = red | G = green |
| aux. supply : | 1 = 24V DC | 2 = 230V AC |
| display : | 40 = 4 digits | 60 = 6 digits |

GS Gebhardt & Schäfer Industrie-Elektronik GmbH

Porschestr. 11
D-51381 Leverkusen
Tel. +49 (0) 21 71 / 73 72 2 -0
Fax +49 (0) 21 71 / 73 72 2 -39
Internet: <http://www.GS-GmbH.de>
E-Mail: info@GS-GmbH.de

Kölner Bank eG
IBAN: DE62 3716 0087 0940 9250 10
BIC: GENODED1CGN
Kreissparkasse Köln
IBAN: DE65 3705 0299 0312 0061 45
BIC: COKSDE33

Deutsche Bank AG
IBAN: DE30 3757 0024 0851 0851 00
BIC: DEUTDE33
Foreign Payments:
Account-No. 851 085 1
S.W.I.F.T. DEUTDE33

Geschäftsführer:
Karlheinz Schäfer
Guido Gebhardt
USt.-Nr. DE 123713297
Amtsgericht Köln, HRB 48860
D-U-N-S@: 340802073